

Ständermontage Teil 1
 Stand mounting parts 1
 Montage du pied part 1

TERZO eBoxx

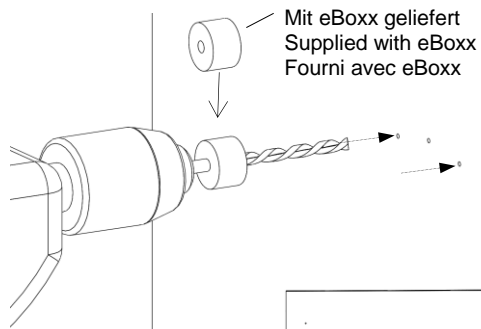

E 635

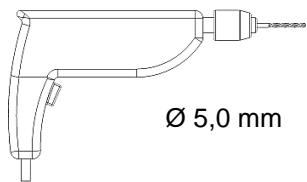
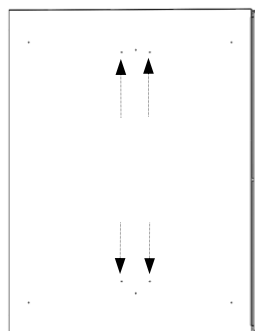

GV 645

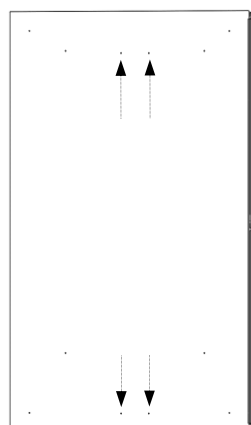
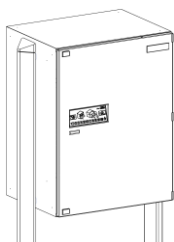

E 635 + A 625

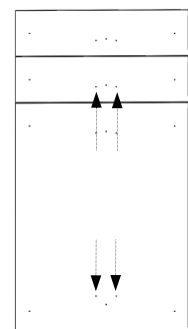
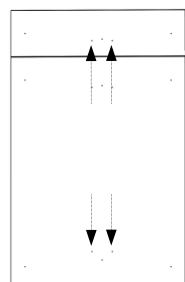
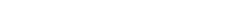
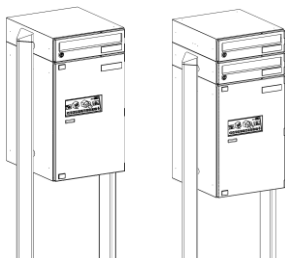

E 635 + A 625

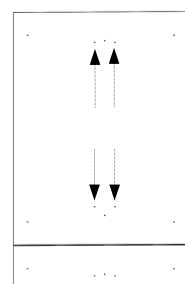
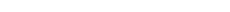
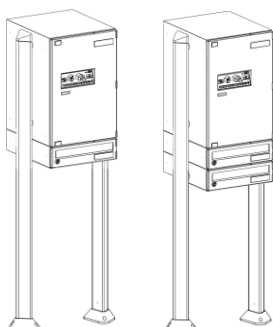

← optional / optional / optionnel

Ständermontage Teil 2
 Stand mounting parts 2
 Montage du pied part 2

TERZO eBoxx

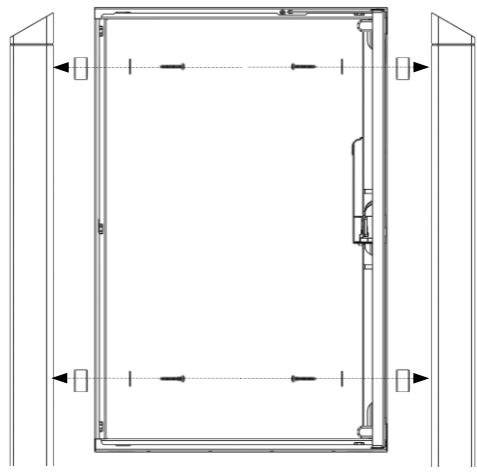
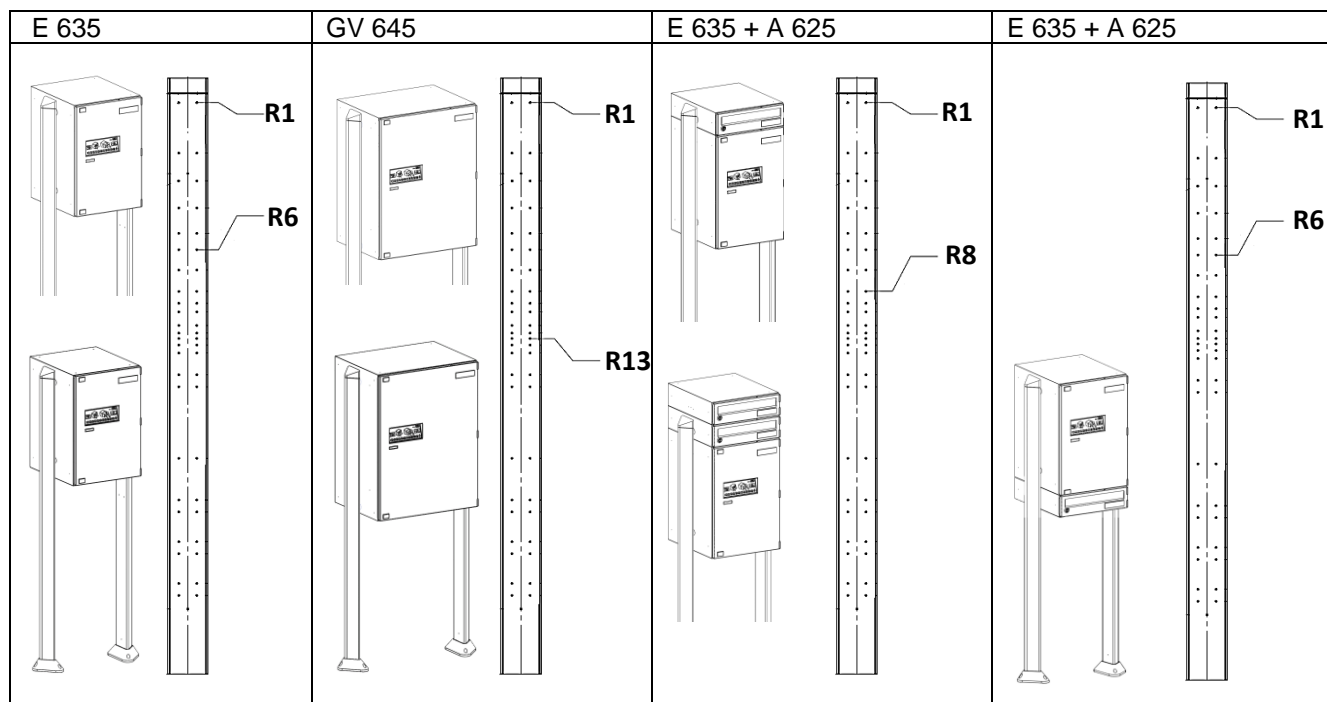
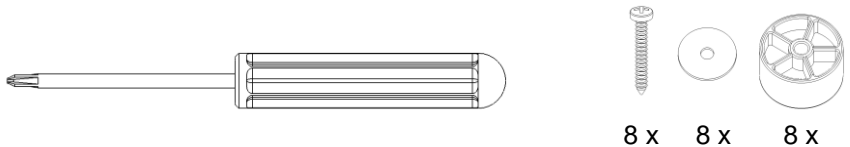

x	mm
R1	25
R6	430
R8	545
R13	675
R15	715

